

BDCOM S5828 Hardware Installation Manual

Table of Contents

Chapter 1 BDCOM S5828 Introduction	1
1.1 Appearance Description for Standard Configuration	1
1.2 BDCOM S5828 Systematic Characteristic Parameters	3
1.3 ROHS Description	4
Chapter 2 Installation Preparation	6
2.1 Caution of Usage.....	6
2.2 Safety Advice.....	6
2.2.1 Safety Principles	6
2.2.2 Safety Notices	6
2.2.3 Safety Principles for Live Working	7
2.2.4 Electrostatic Discharge Damage Prevention.....	8
2.3 Requirements for Common Locations.....	8
2.3.1 Environment.....	8
2.3.2 Location Configuration Prevention	8
2.3.3 Cabinet Configuration	8
2.3.4 Power Requirements.....	9
2.4 Installation Tools and Device.....	9
Chapter 3 Installing the BDCOM S5828 Switch	10
3.1 Installation Flow of BDCOM S5828.....	10
3.2 Installing the Machine Box of the Switch.....	10
3.2.1 Installing the Machine Box on the Desk.....	10
3.2.2 Installing the Machine Box on the Cabinet.....	11
3.3 Connecting the Port.....	11
3.3.1 Connecting the Console Port	11
3.3.2 Connecting Ethernet Management Ports	13
3.3.3 Connecting 10GE Ethernet SFP+ Ports.....	14
3.3.4 Connecting 40/100GE Ethernet QSFP+ Ports	14

3.3.5 USB Interface.....	15
3.4 Checking After Installation.....	15
Chapter 4 Maintaining Switch	17
4.1 Opening the Machine Box.....	17
4.2 Closing Machine Box.....	18
Chapter 5 Hardware Fault Analysis	19
5.1 Fault Separation	19
5.1.1 Faults Relative with Power and Cooling System.....	19
5.1.2 Faults Relative with Port, Cable and Connection.....	19
5.2 Indicator Description.....	19

Chapter 1 BDCOM S5828 Introduction

The section describes the characteristics and parameters of BDCOM S5828 and gives an overview of BDCOM S5828.

1.1 Appearance Description for Standard Configuration

The built-in ports of BDCOM S5828 are: 24 10GE SFP+ ports, 2 40/100GE QSFP+ ports, 1 console port, 1 gigabit management port and 1 USB interface. See table 1-1.

Table 1-1 Attributes of the built-in port

Port	Attribute
10GE optical port	SFP+ interface, LINK/ACT indicator
40/100GE optical port	QSFP+ interface, LINK/ACT indicator
Console port	RJ45 interface, a rate of 9600bps
Ethernet management port	RJ45 interface
USB interface	USB interface

Besides, BDCOM S5828 has two power sockets at its back.

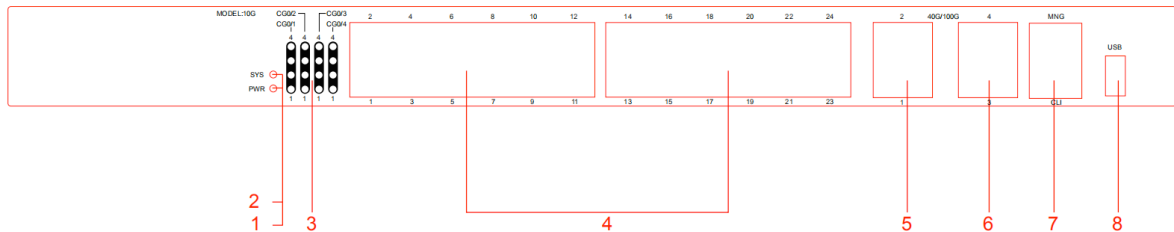

Figure 1-1 Front template of the BDCOM S5828 switch

Table 1-2 Parts at the front template of the BDCOM S5828 switch

No.	Abbrev.	Name	Description
1	Power LED	indicator	Power indicator, refer to indicator description for the detail
2	System LED	Indicator	System indicator, refer to indicator description for the detail
3	MODEL:10GE indicator	40/100Gbps indicator of Ethernet port indicator	1. Work in the mode of 100GE, MODEL: 10G indicator is off; 2. The 40GE port breaks out into 4 10GE ports and combines with QSFP+ port indicator. The QSFP+

			port indicator shows the status of the 4 10GE BREAKOUT indicators.
4	SFP+	10GE Ethernet optical ports	24 10GE SFP+ ports
5	QSFP+	40/100Gbps optical ports	2 QSFP+ 40/100Gbps ports
6	QSFP+	40/100Gbps optical ports	2 QSFP+ 40/100Gbps ports
7	MNG and CLI	Gigabit Ethernet management ports CLI port	Gigabit Ethernet Base-T ports, 100/1000BASE-T ports Manages the switch locally
8	USB	USB	USB interface

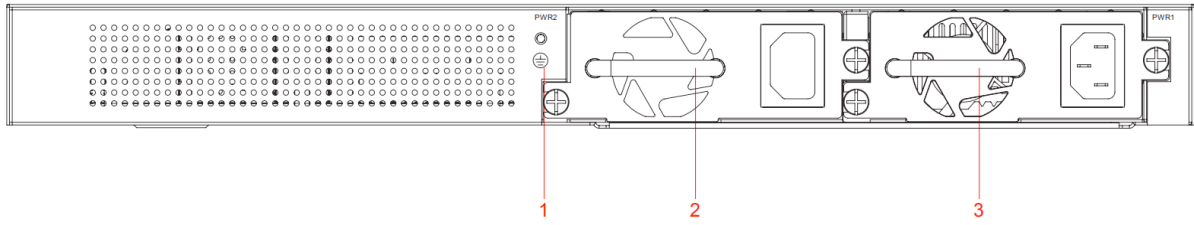

Figure 1-2 Back template of the BDCOM S5828 switch

Table 1-3 Parts at the back template of the BDCOM S5828 switch

No.	Abbrev.	Name	Description
1	/	Grounding column	The grounding must be fine.
2	PWR2	Power slot	dual power backup, hot swap
3	PWR1	Power slot	dual power backup, hot swap

1.2 BDCOM S5828 Systematic Characteristic Parameters

Protocol standard	Supported standard	IEEE 802.1d Spanning Tree Protocol IEEE 802.1s multiple spanning trees IEEE 802.1p Class of Service IEEE 802.1q tagged VLAN IEEE 802.3x Flow control IEEE 802.3z asymmetric flow control IEEE 802.3ad Link aggregation
	IP routing protocol standard	RFC 1058 RIP RFC 1723 RIP v2 RFC 1583 OSPF v2
	Network management standard	RFC 1157 SNMP v1/v2 RFC 1213 MIB II RFC 1757 RMON 1,2,3,9
Hardware characteristics	Memory	Flash Memory: 32M Bytes SDRAM: 1GBytes;
	Standard configuration	24 SFP+ 10GE optical ports 4 QSFP+ 40/100Gbps optical ports 1 Console port 1 USB interface 1 gigabit management interface
	Dimensions (W×D×H) mm	442.5×404×44
	Operating temperature/humidity	0°C~40°C; 10%~85% non-condensing
	Storage temperature/humidity	-40°C~80°C; 5%~95% non-condensing

	Power characteristics	Input voltage: AC100~240V, DC36~72V, Input frequency: 47~63Hz, Input current: 3A (MAX), Output voltage: 12VDC, Output current: 5A(MAX)
	Full power consumption	<75W

1.3 ROHS Description

Part Name	Toxic or Hazardous Substances and Elements					
	Pb	Hg	Cd	Cr(VI)	PBB	PBDE
PCBA	○	○	○	○	○	○
Metal Parts	○	○	○	○	○	○
Plastic & Polymer Parts	○	○	○	○	○	○
Cables & Cable Assemblies	○	○	○	○	○	○
Packaging Materials & Assemblies	○	○	○	○	○	○

This table is prepared in accordance with the provisions of SJ/T11364.

○: Indicates that said hazardous substance contained in all of the homogeneous materials for this part is below the limit requirement of GB/T26572

X: Indicates that said hazardous substance contained in at least one of the homogeneous materials used for this part is above the limit requirement of GB/T26572.

The referenced environment-friendly use period logo is determined based on the normal operating conditions (such as temperature and humidity)

(NOTE: These statements apply only to the China RoHS regulations.)



Chapter 2 Installation Preparation

2.1 Caution of Usage

Similar to other electronic products, the semiconductor chip easily gets damaged if you power on or off abruptly and frequently. To restart up the switch of BDCOM S5828, you have to open the power on-off after the power is cut down for three to five seconds.

Avoid severe collision or falling down from the height to protect the parts in the switch.

Use correct outside ports to connect the switch of BDCOM S5828. Do not put the Ethernet plug into the console port (RJ45 8-line socket). Similarly, do not put the console cable into the console port (RJ45 8-line socket).

Note:

- 1) When you plug or dial the power line, keep the power line horizontal with the power socket.
- 2) When the lifetime of our products ends, handle them according to national laws and regulations, or send these products to our company for collective processing.

2.2 Safety Advice

2.2.1 Safety Principles

- Keep dustless and clean during or after the installation.
- Put the cover at the safe place.
- Put tools at the right place where they are not easily falling down.
- Put on relatively tight clothes, fasten the tie or scarf well and roll up the sleeve, avoiding stumbling the machine box.
- Put on the protective glasses if the environment may cause damage to your eyes.
- Avoid incorrect operations that may cause damage to human or devices.

2.2.2 Safety Notices

The safety notices mentioned here means that improper operation may lead to body damage.

- Read the installation guide carefully before you operate the system.
- Only professionals are allowed to install or replace the switch.
- Pull out the AC power socket and close the direct-current power before operating on the machine box or working beside the power source.
- The final configuration of products must comply with relative national laws and regulations.

2.2.3 Safety Principles for Live Working

When you work under electricity, following the following principles:

- Put off ornaments, such as ring, necklace, watch and bracelet, before you operate under live working. When metal articles connect the power to the ground, short circuit happens and components may be damaged.
- Pull out the AC power socket and close the direct-current power before operating on the machine box or working beside the power source.
- When the power is on, do not touch the power.
- Correctly connect the device and the power socket.
- Only professionals are allowed to operate and maintain the device.
- Read the installation guide carefully before the system is powered on.

Note:

- 1) Check potential dangers, such as the humid floor, ungrounded extensible power line and tatty power line.
- 2) Install the emergent on-off at the working room for turning off the power when trouble happens.
- 3) Turn off the power on-off of the switch and plug off the power line before installing or uninstalling the machine box or working beside the power.
- 4) Do not work alone if potential dangers exist.
- 5) Cut off the power before checkout.
- 6) If trouble happens, take the following measures:
 - A. Cut off the system's power.
 - B. Alarm.
 - C. Take proper measures to help persons who are hit by the disaster. Artificial respiration is needed if necessary.
 - D. Seek for medical help, or judge the loss and seek for available help.

2.2.4 Electrostatic Discharge Damage Prevention

Electrostatic discharge may damage devices and circuits. Improper treatment may cause the switch to malfunction completely or discontinuously.

Move or locate the devices according to the measures of electrostatic discharge prevention, ensuring the machine box connects the ground. Another measure is to wear the static-proof hand ring. If there is no hand ring, use the metal clip with the metal cable to clip the unpainted metal part of the machine box. In this case, the static is discharged to the ground through the metal cable of the clip. You can also discharge the static to the ground through your body.

2.3 Requirements for Common Locations

This part describes the requirements for the installation locations.

2.3.1 Environment

The switch can be installed on the desk or the cabinet. The location of the machine box, cabinet planning and indoor cabling are very important for normal system's function. Short distance between devices, bad ventilation and untouchable control plate will cause maintenance problems, systematic faulty and breakdown.

For location planning and device locating, refer to section 2.3.2 "Location Configuration Prevention".

2.3.2 Location Configuration Prevention

The following preventive measures assist you to design the proper environment for the switch.

- Make sure that the workshop is well-ventilated, the heat of electrical devices is well-discharged and sufficient air circulation is provided for device cooling.
- Avoid to damage devices by following the electrostatic discharge prevention procedure.
- Put the machine box at the place where cool air can blow off the heat inside the machine box. Make sure the machine box is sealed because the opened machine box will reverse the cool air flow.

2.3.3 Cabinet Configuration

The following content assists you to make a proper cabinet configuration:

- Each device on the cabinet gives off heat when it runs. Therefore, the sealed cabinet must have the heat-discharge outlet and the cooling fan. Do not put the devices too close, avoiding bad ventilation.
- When you install the machine box at the open cabinet, prevent the frame of the cabinet from blocking the airway of the machine box.

- Ensure that nice ventilation is provided for the devices installed at the bottom of the cabinet.
- The clapboard separates exhaust gas and inflow air, and boost cool air to flow in the machine box. The best location of the clapboard is decided by the air flow mode in the machine box, which can be obtained through different location tests.

2.3.4 Power Requirements

Make sure that the power supply has nice grounding and the power at the input side of the switch is reliable. The voltage control can be installed if necessary. At least a 240 V, 10A fuse or a breaker is provided in the phase line if you prepare the short-circuit prevention measures for a building.

Caution:

If the power supply system does not have good grounding, or the input power disturbs too much and excessive pulses exist, the error code rate of communication devices increases and even the hardware system will be damaged.

2.4 Installation Tools and Device

The tools and devices to install the BDCOM S5828 switch are not provided by the BDCOM S5828 switch. You yourself need to prepare them. The following are the tools and devices needed for the typical installation of the BDCOM S5828 switch:

- Screwdriver
- Static armguard
- Bolt
- Ethernet cable
- Other Ethernet terminal devices
- Control terminal

Chapter 3 Installing the BDCOM S5828 Switch

Caution:

Only professionals are allowed to install or replace the devices.

3.1 Installation Flow of BDCOM S5828

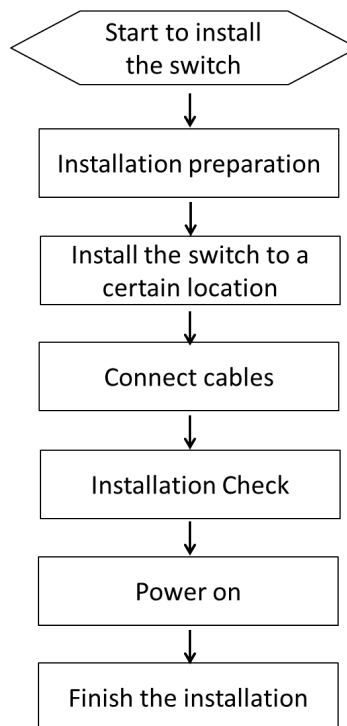

3.2 Installing the Machine Box of the Switch

The installation of the machine box has two modes:

- Installing the machine box on the desk
- Installing the machine box on the cabinet

3.2.1 Installing the Machine Box on the Desk

The BDCOM S5828 switch can be directly put on the smooth and safe desk.

Note:

Do not put things weighing 4.5 kg or over 4.5 kg on the top of the switch.

3.2.2 Installing the Machine Box on the Cabinet

The machine box of the switch is fixed on the cabinet through the brackets. When you fix the brackets, the front template of the switch faces forward. The detailed operations are shown in Figure 3-1.

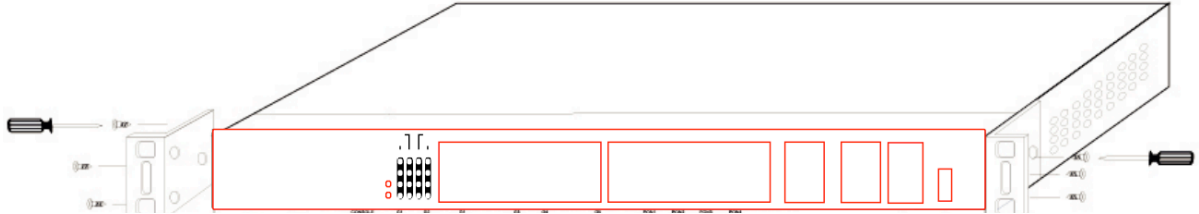

Figure 3-1 Fixing the machine box of the switch

Caution: The switch shown in figure 3-1 does not represent the material BDCOM S5828.

After the brackets are installed, install the switch on the cabinet. See Figure 3-2.

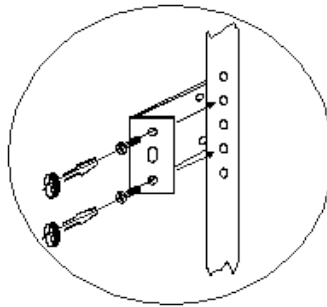

Figure 3-2 Installing the switch on the cabinet

3.3 Connecting the Port

3.3.1 Connecting the Console Port

The switch of BDCOM S5828 has a console port.

The rate of the console port is a value ranging from 1200bps to 115200bps. It has a standard RJ45 plug. It is odd-even optional and has traffic control. After you connect the console port to the serial port of the terminal, such as STAR-510G+ or PC through a console cable, you can configure and monitor the switch of BDCOM S5828 by running a terminal emulation software, such as super Windows terminal. The cable is provided according to the host. The communication parameters of the terminal serial port can be set to a rate of 9600bps, eight data bits, one stop bit, no sum check bit and traffic control.

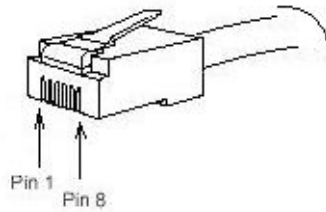

Figure 3-3 RJ-45 connector of the console port

The RJ45 connector of the console port is shown in the following figure. The RJ45 plug corresponds to the RJ45 socket, whose pins can be aligned from left to right with the value from 1 to 8.

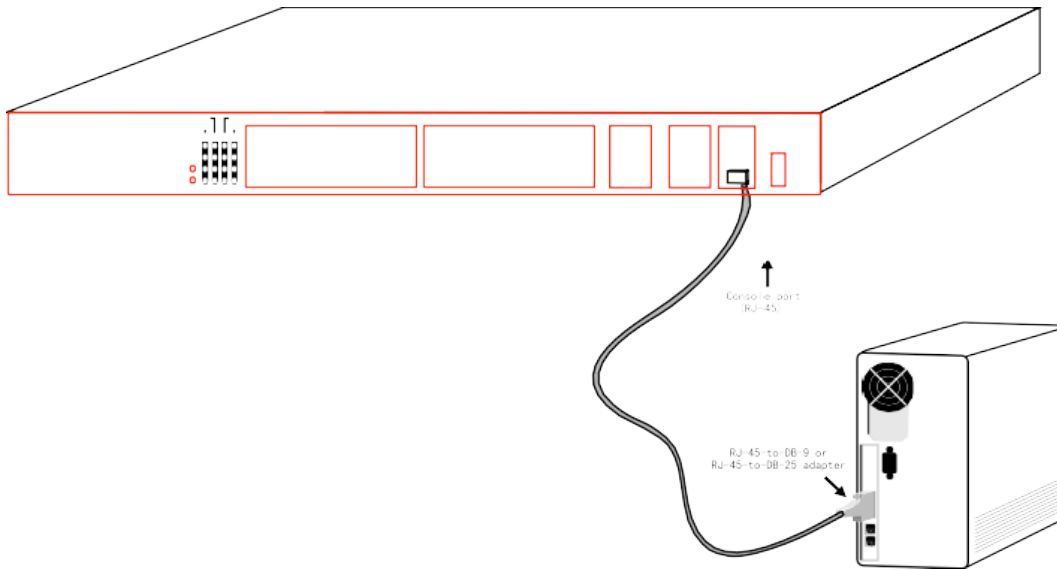

Figure 3-4 Connecting the console port of BDCOM S5828 and computer

Caution: The switch shown in figure 3-4 does not represent the material BDCOM S5828.

Table 3-1 Pins of the console port

No.	Name	Remark
3	TXD	Output
5	SG	
6	RXD	Input

Note:

The cable is used to connect the console port of BDCOM S5828 and the outside monitoring device. One end is RJ45 8-core plug, and the other end of the console cable is DB9. The RJ45 plug is put into the socket of the console port on the BDCOM S5828 switch.

3.3.2 Connecting Ethernet Management Ports

BDCOM S5828 provides with 1 10/100/1000Base-T port. Each port has its corresponding MNG indicator. The indicators are used to indicate the LINK/ACT state. The ports can connect other Ethernet terminal devices through the UTP port and the direct-through or cross network cable. The numbering order of the pins in the UTP port is the same as that in the console port. See figure 3-8.

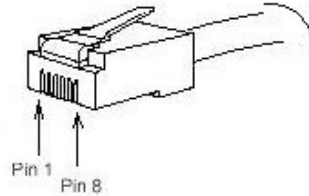

Figure 3-5 RJ-45 connector on the console port

Because the 10/100/1000Base-T ports of BDCOM S5828 support the MDI/MDIX self-identification of the cable, BDCOM S5828 can adopt five types of direct-through/cross network cables when it connects other Ethernet terminals.

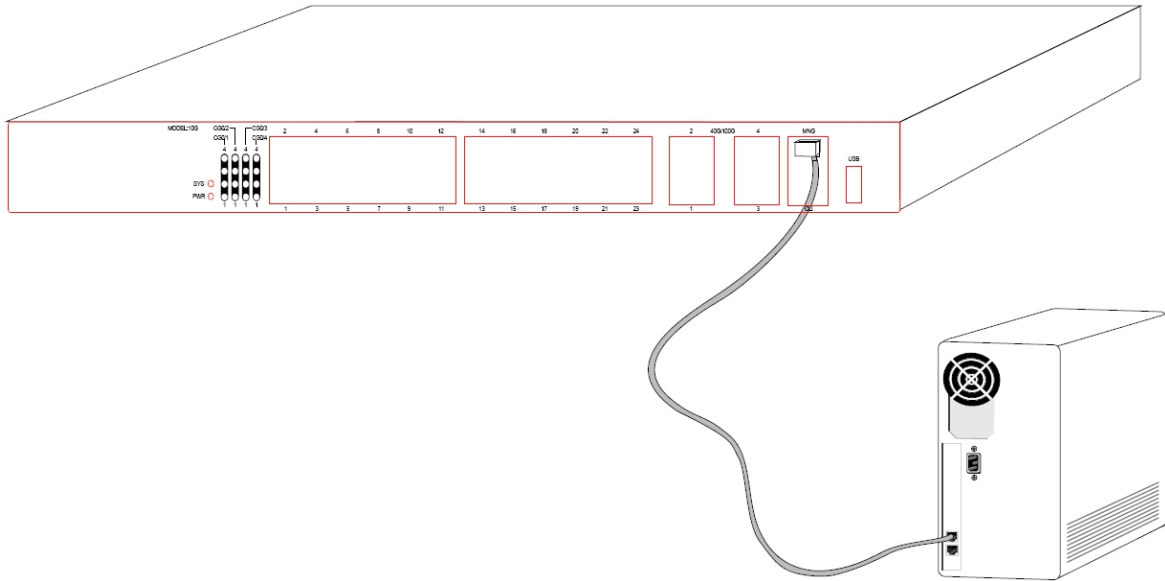

Figure 3-6 Connecting the 1000Base-TX port and other Ethernet terminals

Caution: The switch shown in figure 3-8 does not represent the material BDCOM S5828.

Table 3-1 Pins of Gigabit RJ45

No.	Pin Name	Remark
1	Sending/receiving the normal phase of data 0	TP0+
2	Sending/receiving the paraphase of the data 0	TP0-

3	Sending/receiving the normal phase of data 1	TP1+
4	Sending/receiving the normal phase of data 2	TP2+
5	Sending/receiving the paraphase of the data 2	TP2-
6	Sending/receiving the paraphase of the data 1	TP1-
7	Sending/receiving the normal phase of data 3	TP3+
8	Sending/receiving the paraphase of the data 3	TP3-

3.3.3 Connecting 10GE Ethernet SFP+ Ports

The BDCOM S5828 switch has 24 10GE SFP+ ports. Each port has its corresponding indicator: 1~24. You can connect the SFP+ optical module to the SFP+ port and then you can connect other Ethernet terminal devices through the optical cable.

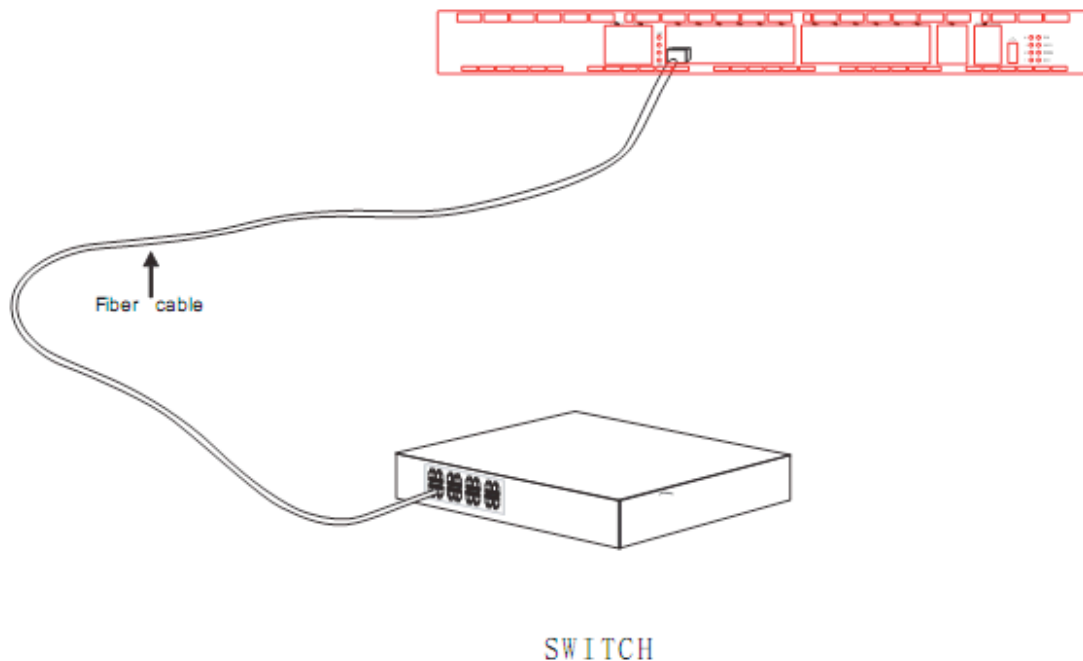

Figure 3-7 Connecting the 10GE SFP+ port and other Ethernet terminals

Caution: The switch shown in figure 3-8 does not represent the material BDCOM S5828.

3.3.4 Connecting 40/100GE Ethernet QSFP+ Ports

BDCOM S5828 provides with 4 40/100 GE QSFP+ ports. Each port has its corresponding indicator: 1~4.

The four ports can be configured into 2 modes:

1. Set the rate of the port to 100Gbps

You can connect the QSFP+ optical port to the QSFP+ optical module and then you can connect other Ethernet terminal devices with 100Gbps optical ports through the optical cable.

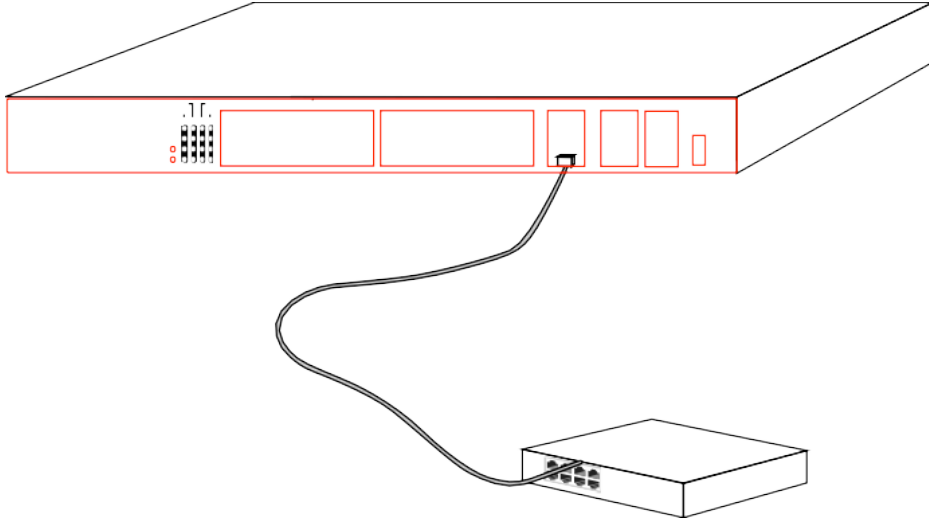

Figure 3-8 Connecting the 100GE QSFP+ port and other Ethernet terminals

2. Set the ports to 4 10GE ports

You can connect the QSFP+ optical module to the optical port and then you can connect other Ethernet terminal devices with 10GE optical ports through the MPO-4*LC optical cable.

3.3.5 USB Interface

BDCOM S5828 provides with 1 USB2.0 interface.

3.4 Checking After Installation

Before electrically starting up the switch, perform the following checkups after the switch is installed:

- If the switch is installed on the cabinet, check whether the installation point between the cabinet and the switch is strong. If the switch is installed on the desk, check whether there is enough space for the switch to discharge its heat and whether the desk is stable.
- Check whether the connected power meets the power requirements of the switch.
- Check whether the grounding line is correctly connected.

- Check whether the switch is correctly connected to other terminal devices.

Chapter 4 Maintaining Switch

Caution:

- 1) Before opening the machine box, make sure that you have released the static you carried and then turn off the power on-off of the switch. Before operating any step in Appendix B, read the section "Safety Advice".
- 2) Before performing operations beside the power source or on the machine box, turn off the power on-off and plug out the power cable.

4.1 Opening the Machine Box

This section describes how to open the cover of the switch, required tools and operation methods.

Caution:

When the power cable still connects the power source, do not touch it.

When you open the cover the switch, you may use the following tools:

- Crossed screwdriver
- Static armguard

Perform the following steps to open the cover of the switch:

- (1) Turn off the power on-off of the switch.
- (2) Plug out all cables connected the back of the switch.



- (3) Take out the bolt from the machine box with the screwdriver.

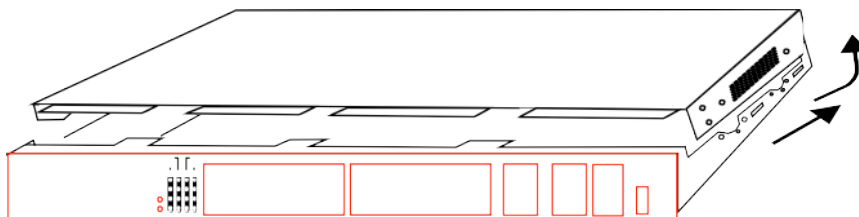

Note:

The machine box comprises of two parts: cover and bottom.

- (4) Open the cover by holding two sides of the cover towards the direction of the arrow key shown in the following figure:

The switch shown in the above figure does not represent the material BDCOM S5828.

Caution: When the cover is opened, put it aside. The mainboard of the system appears.

Note:

After taking off the cover, put it horizontally and avoid it to be crushed or collided. Otherwise, the machine box is hard to install.

4.2 Closing Machine Box

The section mainly describes how to put the cover and close the machine box. Do as follows:

- (1) Put them well according to their locations and joint them together along their sides. See the following figure.



- (2) When the cover and the bottom are closely tied, let the cover slide the slot of the front template at the bottom.
- (3) Nail the bolt and screw it tightly with the screwdriver.
- (4) Reinstall the switch on the cabinet or the desk.



- (5) Reconnect all cables of the switch.

Chapter 5 Hardware Fault Analysis

The part describes how to remove the fault from the switch.

5.1 Fault Separation

The key for resolving the systematic faults is to separate the fault from the system. You can compare what the system is doing with what the system should do to detect the fault. You need to check the following subsystems:

- Power and cooling systems—power and fan
- Port, cable and connection—ports on the front template of the switch and the cables connecting these ports

5.1.1 Faults Relative with Power and Cooling System

Do the following checkups to help remove the fault:

- When the power on-off is at the “ON” location, check whether the fan works normally. If the fan does not work well, check the fan.
- The working temperature of the switch is from 0 to 40 Celsius degrees. If the switch is too hot, check whether the air outlet and air inlet are clean and then do relative operations in section 2.3 “Requirements for Common Locations”.
- If the switch cannot be started and the PWR indicator is off, check the power.

5.1.2 Faults Relative with Port, Cable and Connection

Do the following checkups to help remove the fault:

- If the port of the switch cannot be linked, check whether the cable is correctly connected and whether the peer connection is normal.
- If the power on-off is at the “ON” location, check the power source and the power cable.
- If the console port does not work after the system is started up, check whether the console port is set to a baud rate of 9600 bps, eight data bits, no sum check bit, one stop bit and no traffic control.

5.2 Indicator Description

The LED indicator shows that the switch is running. The following table shows the indicators of the BDCOM S5828 switch and their description:

Abbrev.	Name	Description
PWR	Power indicator	If the power supply of the switch is powered on, the indicator is on.
SYS	System indicator	If the indicator flickers, the system works well. If the indicator is off or on, the system malfunctions.
MNG	Management port indicator	If the indicator is always on, the system is normally linked. If the indicator is off, the port is not linked. If the indicator flickers, there is data transmission.
1~24(LINK/ACT)	SFP+ port indicator	If the indicator is always on, the system is normally linked. If the indicator is off, the port is not linked. If the indicator flickers, there is data transmission.
1~2	QSFP+ port indicator	1. work in the mode of 100GE If the indicator is always on, the system is normally linked. If the indicator is off, the port is not linked. If the indicator flickers, there is data transmission. 2. The 40GE port breaks out into 4 10GE ports The 4 port indicators are on in turn. The interval between two indicators is 5 seconds. The indicators combining with BREAKOUT indicators show the state of 10GE ports.
MODEL:10G (CG0/1~0/4)	The 40GE port breaks out into 4 10GE ports	1. In the mode of 40GE mode, the BREAKOUT indicator is off. 2. The 40GE port breaks out into 4 10GE ports and combines with QSFP+ port indicator 3. The QSFP+ port indicator shows the status of the 4 40GE BREAKOUT indicators

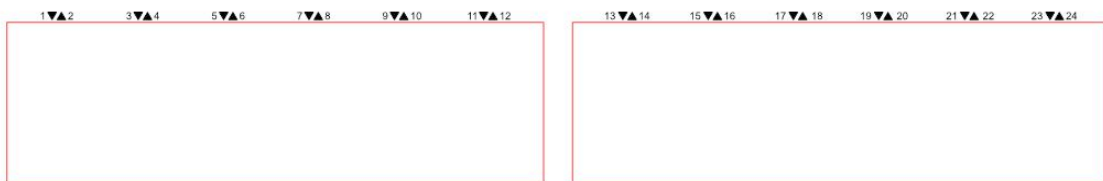

Figure 5-1 SFP+ port indicator

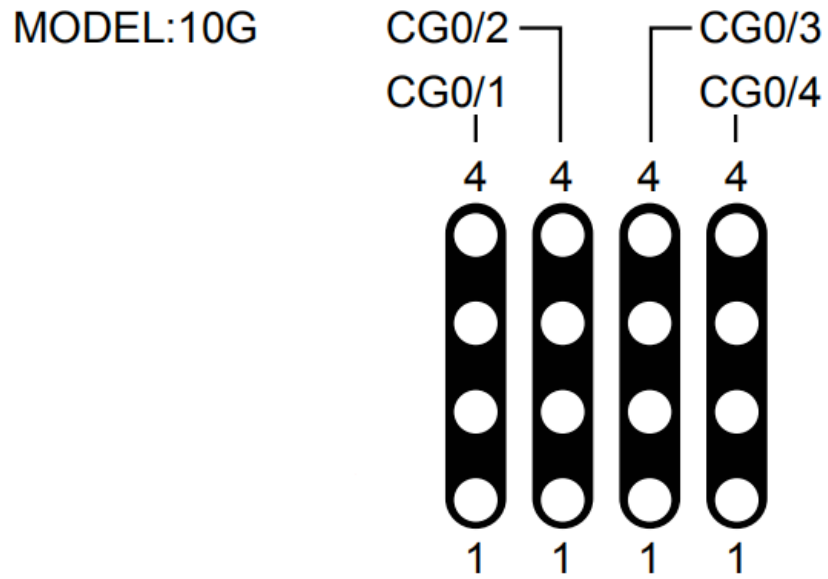

Figure 5-2 40GE BREAKOUT indicator

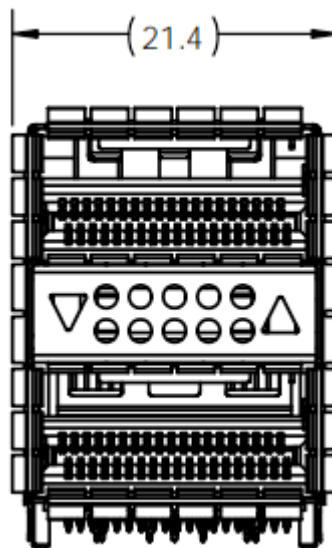

Figure 5-3 QSFP+ port indicator